

FUSION® MS-RA205

Quick Start Manual & Installation Instructions



FUSION®

FUSIONENTERTAINMENT.COM

PRECAUTIONS

Do not attempt to open the unit. There are no user serviceable parts or adjustment's inside.

No responsibility can be taken for use of the unit other than under normally expected operating conditions.

If exposed to direct sunlight or operated for extended periods metal surfaces may become hot. Take care when handling.

USING iPod/iPhones

This unit has been tested with compatible authentic iPod models under normal expected operating conditions, free from any pre-existing defects in either the unit or the iPod.

No responsibility can be taken for use of the unit other than under normally expected operating conditions in conjunction with fully functional and undamaged iPod units which have been manufactured and authorized by Apple Inc.

USB FLASH DRIVES

- **Drive format:** All USB flash drives used with this unit must be formatted to either FAT32 or NTFS format. These are the most commonly used format for USB flash drives.
- **Audio track format:** Audio tracks stored on USB flash drive must be in MP3, M4A or FLAC formats to play on this unit.

CARE AND MAINTENANCE

As with all products exposed to the harsh marine environment, a little care will help preserve the finish. FUSION recommends that you clean any salt water and/ or salt residue from the stereo with a damp cloth soaked in fresh water.

Most marine Stereo's have small vents in their cases to allow a way out for moisture that finds its way in. In some limited instances it is possible for moist air to be drawn into the vents when the air inside the Stereo cools down after it is turned off. Direct sunlight on the front can draw this moisture up against the Window, causing fogging. Turning on the Stereo will speed up moisture removal. Fogging is not abnormal, nor will it harm your Stereo, which is built to withstand the harsh marine environment.

REGISTER YOUR PRODUCT ONLINE

For your own peace of mind, register your product purchase online at www.FUSIONENTERTAINMENT.com

We'll keep you up to date with any news related to your product or new accessories to help you get the most from your product.

RECORD YOUR PRODUCT DETAILS HERE:

SERIAL NUMBER _____ DATE OF PURCHASE _____

AFFIX RECEIPT HERE

CONTENTS

INSTALLATION	4
WIRING DIAGRAM.....	7
CONNECTIONS	8
BUTTON DESCRIPTION	10
GENERAL OPERATION	12
RADIO OPERATION	16
DAB OPERATION.....	17
USB OPERATION	17
AUX OPERATION.....	17
iPod/iPhone OPERATION.....	18
ANDROID DEVICE OPERATION	19
BLUETOOTH OPERATION	20
SiriusXM SATELLITE RADIO.....	22
ZONE OPERATION	23
ADDITIONAL FEATURES.....	24
MENU STRUCTURE.....	25
TROUBLESHOOTING.....	26
FUSION MARINE ACCESSORIES	28
SPECIFICATIONS & LICENSING	30

INSTALLATION

If any modification to the vessel is required, such as drilling holes etc FUSION recommends consultation with your boat dealer or manufacturer beforehand.

Create mounting hole for product and drill Screw Pilot Holes. Refer to mounting template included with product or download from www.FUSIONENTERTAINMENT.com

- Fit mounting gasket
- Insert the unit into the mounting hole
- Use the supplied 4 x self tapping screws, to affix the unit into position.
- Attach screw covers

Note: Appropriate mounting is very important to ensure correct operation. Select a location that allows both free/open airflow around rear of chassis, whilst minimizing exposure to moisture. Allow adequate room at the rear of the unit for the cable looms (approx 2") and underneath the unit (approx 2") if using a SiriusXM tuner (USA Only).



Note: The head unit must not be mounted on more than a 45° angle from the horizontal plain. Failure to follow mounting restrictions could void your warranty.

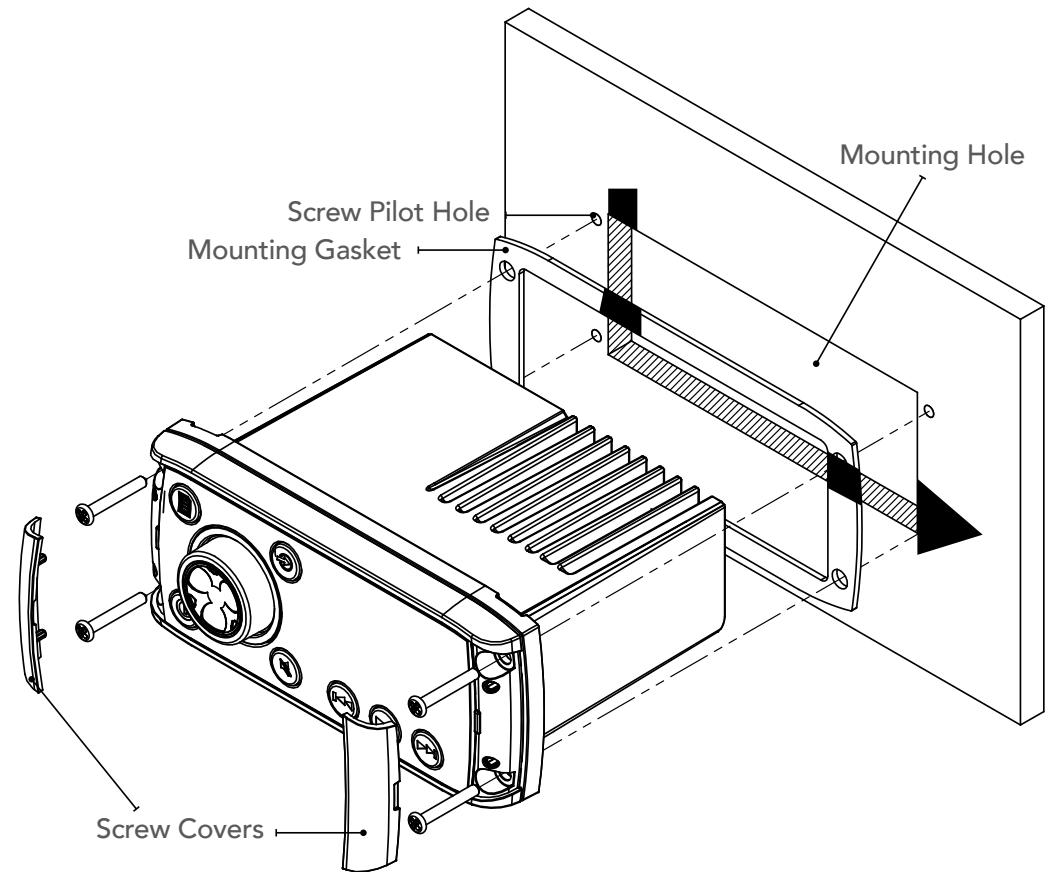

ELECTRICAL WIRING

Caution: The MS-RA205 is designed for vessels with a 12V DC Negative ground electrical system

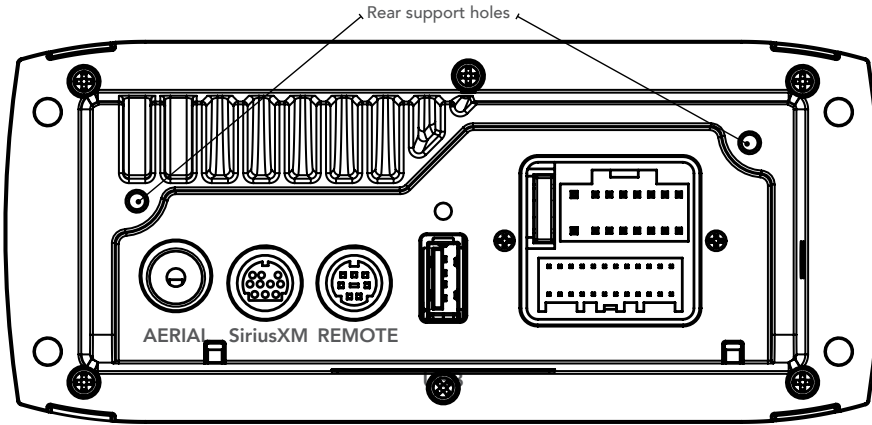

In some cases a rear support strap (not supplied) may be required. Please use the two holes indicated above, to attach the strap using two 8 gauge x 8mm self-tapping screws (not supplied).

INSTALLATION WARNING

- Ensure the marine vessels +12V lead is removed from the battery before any equipment is connected
- Investigate the marine vessels fuel tanks and electrical wiring locations before you begin installation
- Ensure all wiring is protected to avoid damage

When wiring the MS-RA205, ensure that the wires are away from sharp objects and that rubber grommets and insulated bungs are used when routing the wiring. Ensure that when connecting the wires to the speakers and audio system, the terminals and connections are protected from shorting to each other.

Note: Ensure the antenna cable is routed away from any power cables, and is the minimal length, as long cable runs will affect AM reception performance.

For optimum radio reception please ensure you use a dedicated AM/FM ground independent marine antenna.

Please refer to the following site for further info: www.pacificaerials.co.nz

Note: The head unit is IPx5 rated on the face when correctly bulkhead mounted. Failure to mount the head unit correctly may void your warranty.

ELECTRICAL ISOLATION OF THE MS-RA205

The MS-RA205 stereo has a metal chassis which is connected to the Ground / Negative / Black wire (like most other stereos). Extra care should be taken when installing this type of stereo in an aluminium boat or boats with a conductive hull if you require the electrical system to be isolated from the boat hull.

WIRING DIAGRAM

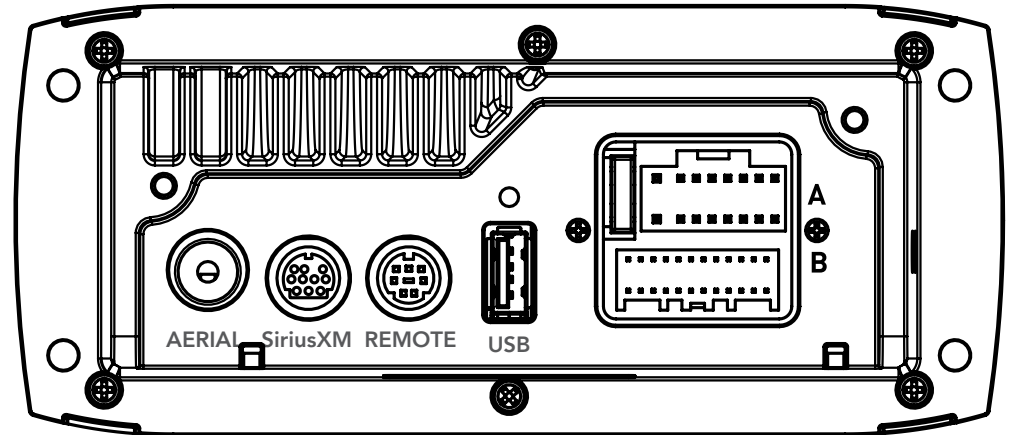

A CABLE

YELLOW	BATTERY (+12 V constant)
RED	IGNITION (+12V switched)
BLACK	GROUND (-12v)
WHITE	SPEAKER ZONE 1 L (+)
WHITE/BLACK STRIPE	SPEAKER ZONE 1 L (-)
GREY	SPEAKER ZONE 1 R (+)
GREY/BLACK STRIPE	SPEAKER ZONE 1 R (-)
GREEN	SPEAKER ZONE 2 L (+)
GREEN/BLACK STRIPE	SPEAKER ZONE 2 L (-)
PURPLE	SPEAKER ZONE 2 R (+)
PURPLE/BLACK STRIPE	SPEAKER ZONE 2 R (-)
BROWN	DIM (+12V switched)
BLUE/WHITE STRIPE	AMPLIFIER ON
BROWN/WHITE STRIPE	TEL MUTE/INTERRUPT AUX

B CABLE

WHITE RCA (Grey wire)	AUX-IN (L)
RED RCA (Grey wire)	AUX-IN (R)
ORANGE RCA (Black wire)	SUB-OUT
ORANGE RCA (Black wire)	SUB-OUT
WHITE RCA (Black wire)	LINE-OUT ZONE 1 (L)
RED RCA (Black wire)	LINE-OUT ZONE 1 (R)

Note: Minimum speaker load impedance 4 Ohm

CONNECTIONS

CONNECTOR A

BATTERY +12VDC

Connect to the battery positive (+12VDC), or bus bars. A fuse or circuit breaker **MUST** be used at the battery end of the cable. Use a minimum wire size of 16AWG for wire length up to up to 6 meters / 20 feet.

IGNITION +12V switched

Connect to a separate switched +12V wire to control stereo ON/Off operation. Alternatively connect to the battery positive (+12VDC), or bus bars.

When the red "Accessory +12V switched" wire is not required for ignition on/off control, it **MUST** be connected together with the Yellow "Battery +12V" wire at the MS-RA205 head unit wiring loom.

GROUND WIRE — Recommended minimum wire size for Negative Ground wire: 16AWG for wire length up to up to 6 meters / 20 feet.

DIM — Connect to vessel lighting system to dim LCD and button illumination when vessel lights are turned on. When connecting the DIM input ensure the wire gauge used is suitable for the fuse supplying the circuit being connected to.

AMPLIFIER ON — When using an external amplifier connect to the "Remote turn ON" connection on the external amplifier.

TELE MUTE / INTERRUPT AUX — Connect to handsfree kit to either mute the stereo or switch to AUX to hear call. When this line is taken to ground the stereo is muted.

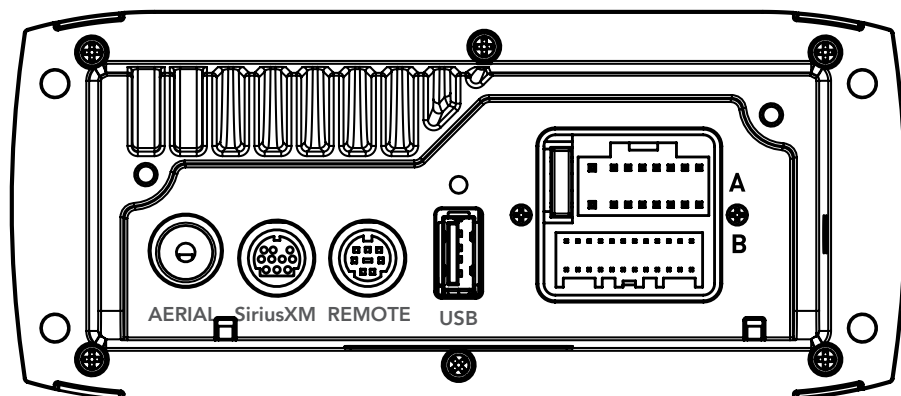

CONNECTOR B

AUX INPUT — Connect an Auxiliary source to the left and right RCA (White = L, Red = R).

SUBWOOFER OUT (DUAL MONO) — Connect to a subwoofer amplifier, volume control linked to Zone 1. (Orange + Orange)

LINEOUT ZONE 1 — Connect to an amplifier, volume control linked to Zone 1. (White = L, Red = R).

REAR CONNECTORS

ANTENNA CONNECTION — Connect an AM/FM marine antenna.

Note: Boat installations do not typically offer the best ground plane environment. For optimum performance a ground plane independent antenna is recommended.

USB/iPod/MTP CONNECTION — Connect a USB key / flash drive (not included), a FUSION Marine Uni-Dock (not included), a MTP device or a certified Apple iPod sync cable (not included).

Media Transfer Protocol (MTP): MTP is a standard developed for connecting media (music) devices over USB. It has been adopted on a number of platforms including Android. FUSION currently supports a range of smartphones utilising MTP. Refer to www.fusionelectronics.com for the latest list of support devices.

SiriusXM SATELLITE RADIO (USA only) — (A) Connect to SiriusXM Connect Vehicle Tuner (not included). (B) Connect the MS-BT200 Bluetooth module (not included). (C) Connect the MS-DAB100A DAB+ Module and antenna (not included).

WIRED REMOTE / NMEA 2000 — Connect a the MS-RA205 Stereo to a FUSION remote control network (cable supplied) or connect to an existing NMEA 2000 network with FUSION optional accessories (not supplied with Stereo):

MS-RA205 NMEA 2000 Drop Cable: CAB000863





FUSION NMEA 2000 T-Connector: CAB000581





Important Note: Adaptor cable CAB000862, provided with the MS-RA205 **MUST** not be used to connect the MS-RA205 to an existing NMEA 2000 network. Existing networks are normally powered separately. The non-powered drop cable (CAB000863) is available from FUSION for connecting to existing NMEA 2000 networks.

Note: FUSION recommends updating all remote(s) software via the MS-RA205 at time of installation to ensure compatibility. This can be done via the Update menu. Please refer to your remote manual for more information.

BUTTON DESCRIPTION



<p>ROTARY ENCODER Turn To adjust volume, move up or down a menu structure, or adjust a specific setting.</p> <p>Press To select a highlighted option, confirm a setting. Press to step through each zone for volume adjustment.</p> <p>Press and Hold For quick access to subwoofer level adjustment</p>	
<p>POWER Press to turn the unit ON/OFF.</p> <p>Press and Hold Press and hold for 10 seconds to 'Reset' the stereo.</p>	
<p>MENU Press to enter Menu System. Press to return to previous screen. Press and Hold To exit the menu system.</p>	
<p>MUTE Mutes sound in all zones.</p>	

<p>BACK/PREVIOUS Short Press iPod/MTP Device/Bluetooth/USB - Select the previous track. AM/FM - Start tuning down the frequency spectrum or channel. In Auto mode (AM/FM) press to seek down the spectrum to the next available station. In Preset (AM/FM) mode step to previous Preset.</p> <p>Note: Preset mode is only available if two or more Presets are saved. SiriusXM (USA Only) - Step down the channel list DAB - Step back a station in the ensemble. At the beginning of the ensemble the stereo will step to the previous ensemble.</p> <p>Press and Hold iPod/USB - Rewind the current track. AM/FM - In MANUAL mode fast station stepping. SiriusXM (USA Only) - Fast browse down the channel list. Release button to select channel.</p>	
<p>FORWARD/NEXT Short Press iPod/MTP Device/Bluetooth/USB - Select the next track. AM/FM - Start tuning up the frequency spectrum or channel. In Auto mode (AM/FM) press to seek up spectrum to the next available station. In Preset (AM/FM) mode step to next Preset.</p> <p>Note: Preset mode is only available if two or more Presets are saved. SiriusXM (USA Only) - Step up the channel list DAB - Step forward a station in the ensemble. At the end of the ensemble the stereo will step to the next ensemble.</p> <p>Press and Hold iPod/USB - Fast forward the current track. AM/FM - In MANUAL mode fast station stepping. SiriusXM (USA Only) - Fast browse up the channel list. Release button to select channel.</p>	
<p>SOURCE Press to cycle through sources AM - FM - AUX - iPod - MTP Device - USB - DAB - Bluetooth - SiriusXM (USA only) note: Disconnected sources may not be displayed.</p>	
<p>PLAY/PAUSE Short Press iPod/MTP Device/Bluetooth/USB - Pause / resume the current track. AM/FM - Press to cycle through tuning modes (auto, manual, presets). SiriusXM (USA Only) - Press to cycle through tuning modes (channels, presets)</p> <p>Note: Preset mode is only available if two or more Presets are saved. DAB - Select to scan for DAB stations</p> <p>Press and Hold AM/FM/SiriusXM/DAB - Store the current station/channel as a Preset</p>	

GENERAL OPERATION

INITIAL SETUP

Important: The Tuner Region must be selected for correct operation. Default - USA.
See section: Tuner Region Selection

ADJUSTING THE VOLUME

Turn the 'Rotary Encoder' to adjust the volume.



ZONE VOLUME

Press the 'Rotary Encoder' to step through zones.



SETTINGS

Press the 'Menu' button and select 'Settings'. Select the desired setting to adjust.

Note: Whilst in Settings the 'Menu' button acts as a back/return to the previous screen. Any key press exits the menu screen.

TONE — Adjust the Bass/Middle/Treble settings. Press the 'Rotary Encoder' to cycle between Bass/Middle/Treble

ZONE SETUP — The MS-RA205 Marine Stereo features Multi-Zone technology which enables 2 'Zones' with independent volume/balance control.

Select the Zone you wish to setup.

Select 'Balance' to adjust the audio balance from left to right within the selected zone.

Select 'Volume Limit' to set the maximum volume limit within the selected zone.

Select 'Zone Name' to give the zone a name of your choice. Rotate the rotary encoder to change the character. Press the rotary encoder to select. Press the 'Previous' button to delete characters

- To save changes press the 'Play' key

- To exit without saving any changes: press the 'Menu' key.

SUBWOOFER — Select 'Settings' then 'Zones' then 'Subwoofer'.

Select 'Sub level' to set the desired maximum subwoofer output volume.

Select 'Sub Filter' to select the desired cut-off frequency.

55Hz - 85Hz - 120Hz - 160Hz

Default: 85Hz

Note: From any source screen press and Hold the 'Rotary Encoder' for quick access to subwoofer level adjustment

LCD — Press the Rotary Encoder to cycle between Contrast and Brightness. Turn to adjust.

KEY SOUND — Press the Rotary Encoder to cycle between 'On' and 'Off'.

LANGUAGE — Select the desired language for the on screen display
English - Deutsch - Nederlands - Espanol - Italiano - Francais

SEARCHING — If your iPod/iPhone or MTP device contains more than 100 artists, songs or albums, you can use FUSION Alpha Search Technology (FAST) to quickly navigate by letter or number. Use this option to control when to display the FAST menu.

- Off. The song/album list is displayed but not the FAST menu.

- 100 -800. Display the FAST menu when your device contains more than the selected number of items.

POWER SAVE — Press the Rotary Encoder to cycle between 'On' and 'Off'.

OFF LCD/Buton backlight on constantly

ON LCD/Buton backlight turns off after 30 seconds of non-activity

TEL MUTE — Control the connection to a cell phone hands-free kit.

MUTE — Mutes the audio output from the MS-RA205 Marine Stereo when a call is received on your cell phone.

AUX — Allows the received call to be broadcast through the Auxiliary input.

Note: This feature may not operate with all available hands-free kits.

Hands free kit must be connected to the TELMUTE input and AUX input.

TUNER REGION — Select the appropriate Region.



Important: The correct Tuner Region must be selected. Default - USA

Note: The MS-RA205 can be completely disconnected from the constant +12V voltage supply (Battery switch) with no settings lost.

DISABLE SOURCES — Use this option to turn on/off the AM source.

For example this is useful if you only wish to listen to FM and do not wish to step through AM when selecting a tuner source.

Note: USB/iPod/MTP Device source only available if a device is connected.

Accessory (Shared external MS-BT200 Bluetooth, SiriusXM or MS-DAB100 DAB+ Receiver) — connect module to port and select device to enable the source.

Important Note: SiriusXM is only available if the Tuner region is set to USA. DAB+ is only available if tuner region is set to Europe or Australasia.

SET DEVICE NAME — Select 'Set Device Name' to give the MS-RA205 a network name of your choice. The name is visible to other devices (Marine Wired Remotes MS-NRX200i) connected to the same FUSION network. Rotate the rotary encoder to change the character. Press the rotary encoder to select. Press the 'Previous' button to delete characters.

- To save changes press the 'Play' key.
- To exit without saving any changes: press the Menu key.

UPDATE – MS-RA205 — This option is provided for future MS-RA205 software updates. **MS-DAB100** — This option is provided for future software updates to the MS-DAB100 attached to your MS-RA205. **NRX Series of Wired Remote's** — This option is provided for future software updates to remote controls (NRX Series) attached to your MS-RA205.

Note: FUSION recommends updating all remote(s) software via the MS-RA205 at time of installation to ensure compatibility. This can be done via the Update menu. Please refer to your remote manual for more information.

FACTORY RESET — The factory reset function will return all settings in the MS-RA205 to the factory default value.

Warning: All AM and FM station presents are erased. Tuner regions are reset to USA. All zones are enabled and zone settings, tone, subwoofer filter settings, source settings and device name are returned to default values.

ABOUT — This option displays the MS-RA205 Marine Stereo software version, remote control version, F-Link software versions and DAB version.

RADIO OPERATION

SOURCE SELECTION

Press the 'Source' button and cycle to desired source.

▶ AM ▶ FM ▶ AUX ▶ iPod ▶ MTP Device ▶ USB

Note: Disconnected sources may not be displayed.

STATION SEARCH

Press 'Play' to cycle between tuning seek modes. ▶ Auto ▶ Manual ▶ Preset

AUTOMATIC SEEK TUNING

Press 'Play' to cycle to Auto tuning mode. Press the 'Previous' or 'Next' button to scan to the next station.

MANUAL SEEK TUNING

Press 'Play' to cycle to Manual tuning mode. Press the 'Previous' or 'Next' button to step up and down the spectrum. Press & Hold the 'Previous' or 'Next' button for fast frequency/channel stepping.

PRESET TUNING MODE

Press 'Play' to cycle to Preset tuning mode. Press the 'Previous' or 'Next' button to select previous or next preset.

Note: Preset function is only available when more than one preset has been saved.

PRESETS

STORING A STATION AS A PRESET

When listening to a station/channel (AM/FM), press and hold the 'Play' button to store preset. Alternatively: Press the 'Menu' button and select 'Presets'. Select 'Save Current'. Note: There are 15 presets available per band.

VIEW PRESETS

Press 'Menu' and select 'Presets'. Select 'View Presets'. Use the 'Rotary Encoder' to cycle and select a saved preset.

REMOVE PRESET

Press 'Menu' and select 'Presets'. Select 'Remove Preset'. Select the desired preset.

REMOVE ALL PRESETS

Press 'Menu' and select 'Presets'. Select 'Remove All Presets'.

DAB PLAYBACK (OPTIONAL EXTERNAL DAB+ MODULE & ANTENNA)

When you connect a compatible Digital Audio Broadcasting (DAB) module and antenna, such as the FUSION MS-DAB100A to the FUSION MS-RA205 stereo, you can tune in to and play DAB stations.

DAB broadcasts are not available in all regions. When the stereo is not set to a compatible region, the DAB source is not available

Setting the Tuner Region

You must select the region you are in, Europe or Australasia, to receive DAB stations.

- 1 Select  > SETTINGS > TUNER REGION
- 2 Select the region you are in EUROPE or AUSTRALASIA

Scanning for DAB Stations



Before you can scan for DAB stations, you must connect a compatible DAB module and antenna (not included) to the stereo. Because DAB signals are broadcast in select countries only, you must also set the tuner region to a location where DAB signals are broadcast.

- 1 Select the DAB Source
- 2 Select  to scan for available DAB stations

When scanning is complete, the first station in the lowest numbered ensemble found begins playing.



NOTE: After the first scan is complete, you can select  again to re-scan for DAB stations. When the re-scan is complete, the system starts playing the first station in the ensemble you were listening to when you started the re-scan.

Changing DAB Stations



- 1 Select the DAB source, If necessary, select  to scan for local DAB stations.
- 2 Select  to change the station.

When you reach the end of the current ensemble, the stereo automatically changes to the first available station in the next ensemble.

Selecting a DAB Station from a List

- 1 Select the DAB source, If necessary, select  to scan for local DAB stations.
- 2 Select  > BROWSE > STATIONS.
- 3 Select a station from the list.

Selecting a DAB Station from a Category

- 1 Select the DAB source, If necessary, select  to scan for local DAB stations.
- 2 Select  > BROWSE > CATEGORIES.
- 3 Select a category from the list.
- 4 Select a station from the list.

DAB Presets

You can save your favorite DAB stations as presets for easy access. You can save up to 15 DAB-station presets.

Saving a DAB Station as a Preset

- 1 With the DAB source selected, change the stereo to a DAB station.
- 2 Select  > BROWSE > PRESETS > ADD PRESET.

TIP: You can quickly save the selected DAB station as a preset by holding .

Selecting a DAB Preset from a List

Before you can select a DAB preset from a list, you must save at least one DAB station as a preset.

- 1 Select the DAB source.
- 2 Select  > BROWSE > PRESETS > VIEW PRESETS.
- 3 Select a preset from the list.

Removing DAB Presets

- 1 With the DAB source selected, select  > BROWSE > PRESETS.
- 2 Select an option:
 - To remove one preset, select REMOVE PRESET, and select the preset.
 - To remove all presets, select REMOVE ALL PRESETS.

Updating the DAB Module Software

From time to time software updates may be made available for download from the FUSION web site. Full update instructions will be provided with the download.

USB OPERATION

SOURCE SELECTION



Press the 'Source' button and cycle to USB (only if USB flash drive is connected).

PLAYING AUDIO TRACKS FROM USB FLASH DRIVES

You can store audio tracks (MP3, M4A and FLAC formats only) on a USB flash drive for playback. Audio tracks can be stored in folders on the flash drive and selected for playback, as required. The flash drive must be formatted to FAT32 or NTFS (these are the most commonly used flash drive format).

Press the 'Menu' button to display the attached devices, then select the folder on your USB flash drive. Turn the encoder to navigate down the folder list and press to select.

Note: Press the 'Menu' button to return to the previous menu screen.

PLAY/PAUSE	Play or Pause the track	
BACK/PREVIOUS	Short Press: Selects previous track Press and Hold: Rewind track	
NEXT/FORWARD	Short Press: Selects next track Press and Hold: Fast-forward track	

REPEAT

Press the 'Menu' button and select 'Repeat', to repeat all playable tracks within the folder of the current selection. Default: On.

SHUFFLE

Press the 'Menu' button and select 'Shuffle', to shuffle all playable tracks within the folder of the current selection. Default: Off.

Important: Ensure the USB Device is formatted as Fat32 or NTFS.

AUX OPERATION

CONNECTING AN AUXILIARY AUDIO DEVICE

The Left & Right AUX RCA plugs are located on accessory cable 'B' at the rear of the unit.

Connect your auxiliary audio device.

Note: You may require an adapter cable to connect your device.

ADJUSTING AUX INPUT LEVEL (dB figure)

To allow for the wide range of input levels, the AUX input has adjustable input gain (dB). The dB value is displayed on the AUX screen.

- Increase gain (volume) by pressing the Forward key (1dB steps up to 9dB)
- Decrease gain by pressing the Rewind key (1dB steps down to -9dB).

LISTENING TO YOUR AUXILIARY AUDIO DEVICE

Press 'Source' and cycle to AUX mode. Start playback on your auxiliary audio device.

- Use both the volume control on your auxiliary device (if available) and the volume control on the FUSION Marine Stereo to set the volume level.

iPod/iPhone OPERATION

CONNECTING AN iPod/iPhone

Connect a FUSION compatible Marine Dock to gain the benefits of integrated housing for your iPod or iPhone. Alternatively a certified Apple iPod sync cable can be used to connect your iPod/iPhone to the MS-RA205.

LISTENING TO AN iPod/iPhone

Press 'Source' button and cycle to iPod. Playback of the iPod/iPhone will start automatically. Only available if a iPod/iPhone is connected.

iPod/iPhone NAVIGATION

Press the 'Menu' button to enter the iPod menu. The rotary encoder operates similar to the click wheel on your iPod. Turn to navigate and press to enter.

Note: Press the 'Menu' button to return to the previous menu screen.

PLAY/PAUSE Play or Pause the track



BACK/PREVIOUS Short Press: Press once to jump back to start of current track.
Press twice to select previous track.
Press and Hold: Rewind track



NEXT/FORWARD Short Press: Selects next track
Press and Hold: Fast-forward track



iPod SETTINGS

REPEAT

Press the 'Menu' button and select 'iPod Settings', select 'Repeat'.

SHUFFLE

Press the 'Menu' button and select 'iPod Settings', select 'Shuffle'.

F.A.S.T

FUSION ALPHA SEARCH TECHNOLOGY

If your iPod contains more than 100 Artists, Songs or Albums you can use F.A.S.T to quickly navigate by letter or number.

Example: Press the 'Menu' button and select 'Artists'. Select 'D' and the first 'Artist' beginning with 'D' will automatically highlight. Using the 'Rotary Encoder' you can then scroll up or down from this selection.

NO iPod CONNECTED

If this appears on the display possible causes are:

- Ensure the iPod/iPhone is correctly connected
- Ensure the cable is not excessively bent
- The iPods battery remains low (refer to iPod manual and charge the battery)
- Reset your iPod/iPhone
- Ensure your iPod/iPhone is on the list of supported models.
(refer to www.FUSIONENTERTAINMENT.com for a list of supported models)

ANDROID (MTP) DEVICE OPERATION

Media Transfer Protocol (MTP) is a standard developed for connecting media (music) devices over USB. It has been adopted on a number of platforms including Android. FUSION currently supports a range of smartphones utilising MTP.

Refer to www.FUSIONENTERTAINMENT.com for the latest list of support devices.

CONNECTING A MTP Device

Connect a FUSION UNI-Dock (MS-UNIDOCK) to gain the benefits of integrated housing and charging for your MTP device. Alternatively your device USB cable can be used to connect to the MS-RA205.

LISTENING TO A MTP DEVICE

Press 'Source' button and cycle to MTP. Playback will start automatically. Only available if a MTP device is connected.

INITIAL SONG TITLE LOADING FROM MTP DEVICES

Following connection to the USB connector, the MS-RA205 will download the full list of song names from the device to create a song title index. This process must be completed before music playback can begin. For devices with large music collections this may take several minutes. The song count will be displayed during this process. Other sources can be selected while this process is underway. The file name download and indexing will continue as a background task.

Note: Your entire music collection may not be available for playback. Only audio tracks stored in MP3 or M4A format are indexed.

MUSIC FOLDER STRUCTURE

FUSION recommends that folders contain no more than 300 files each. Exceeding this limitation may cause the phone to become unresponsive and the FUSION Stereo to reset the USB link to the phone. Music files must be located in a folder using one of the following names. The folder must be located in the root directory of your device.

My Music
My_Music
mobile
Music

SD cards may be used on devices that support them. Songs may be copied to both the phone's internal memory and the external memory. The rules regarding folder naming apply to both memory types.

MTP DEVICE NAVIGATION

Press the 'Menu' button to enter the MTP menu. Songs stored in MP3 and M4A format (see note below) can be played on the FUSION Stereo. The FUSION Stereo will display your music collection in groupings of Songs, Albums and Artists allowing you to browse in these categories. In addition to the above groupings your music collection can be browsed according to the folder structure on your device. The root folder for each storage memory on your device memory will be displayed in the Settings menu, for example; PHONE, CARD, etc. Storage card locations on phones are also supported.

Note: Different operating systems and phones provide varying levels of support for MTP. Please refer to www.FUSIONENTERTAINMENT.com for device compatibility information.

MTP DEVICE CONTROL

PLAY/PAUSE Play or Pause the track
BACK/PREVIOUS Short Press: Press once to jump back to start of current track.
Press twice to select previous track.
NEXT/FORWARD Short Press: Selects next track



F.A.S.T

FUSION ALPHA SEARCH TECHNOLOGY

If your MTP device contains more than 100 Artists, Songs or Albums you can use F.A.S.T to quickly navigate by letter or number.

Example: Press the 'Menu' button and select 'Artists'. Select 'D' and the first 'Artist' beginning with 'D' will automatically highlight. Using the 'Rotary Encoder' you can then scroll up or down from this selection.

MTP SETTINGS

To change a setting in the MTP settings menu:

1. Press the Menu key while the MTP Source screen is displayed.
2. Turn and then press the Rotary Encoder to select one of the following settings to change.
 - Repeat On/Off. Repeat mode is turned on/off (not supported on all devices)
 - Shuffle On/Off. Random play shuffle is turned on/off (not supported on all devices)

BLUETOOTH OPERATION

The external MS-BT200 Bluetooth module is designed to provide Bluetooth audio streaming from a compatible smartphone or media player directly to your MS-RA205. The MS-BT200 is connected to the Satellite Radio (SiriusXM) connector of your stereo.

Note: The MS-BT200 cannot be operated simultaneously with a Satellite Radio (SiriusXM) receiver or MS-DAB100A. For installations where the Satellite Radio (SiriusXM) socket is not available the FUSION MS-BT100 audio only Bluetooth module is recommended.

The MS-BT200 supports control (Play/Pause/Next/Back) of the media device from the MS-RA205. Song information such as song title, artist name and duration are displayed, depending on the capability of your phone and music application.

The MS-BT200 does NOT provide phone call control. Hands free operation of the phone is not supported from the FUSION stereo.

SELECTING THE BLUETOOTH SOURCE ON THE MS-RA205

Once you have installed the MS-BT200 you will need to enable the Bluetooth source. This operation will be determined by the Tuner region you have selected.

Tuner Region - USA

When USA Tuner region is selected, press the menu button and select Settings>Accessory then select the source to enable SiriusXM or Bluetooth.

Tuner Region - Australasia-Europe-Japan

In these Tuner regions once the MS-BT200 is installed and connected the source will be available.



Please refer the MS-BT200 Installation Instructions for the following:

- Installing the MS-BT200 Bluetooth Module
- Bluetooth Pairing
- Choosing a Device from the paired list

BROWSING MUSIC COLLECTIONS OVER BLUETOOTH NOT SUPPORTED

Browsing music collections from the MS-RA205 is not supported over Bluetooth. Initial song and Playlist selection must be done on the media device. However the FUSION Stereo does provide basic playback control with the Play / Pause, Next and Previous keys. Forward and Rewind functions are not supported.

BLUETOOTH DEVICE CONTROL

PLAY/PAUSE	Play or Pause the track	
BACK/PREVIOUS	Short Press: Press once to jump back to start of current track. Press twice to select previous track.	
NEXT/FORWARD	Short Press: Selects next track	

Note: The availability of song information such as song title, artist name and track duration is dependent on the capability of your phone and music application. Album cover artwork and Shuffle/Repeat Status icons are not supported over Bluetooth.

BLUETOOTH SETTINGS

To change a setting in the Bluetooth settings menu:

1. Press the Menu key while the BT Source screen is displayed.
2. Turn and then press the Rotary Encoder to select one of the following;

- List of Paired Bluetooth media devices.

To connect to an active device on the Paired Devices list rotate the rotary encoder to select the device. Press the rotary encoder to select the check box.

The device must be turned on, with Bluetooth on and not connected to another Bluetooth device, otherwise it will not connect.

DISCOVERABLE

Enable this option to make the MS-BT200 Bluetooth module discoverable to Bluetooth media devices. Press the encoder to select/deselect the check box.

Note: To prevent interruption to audio streaming over Bluetooth it is recommended that the Discoverable feature is turned off after pairing your device to the MS-RA205.

REMOVE DEVICE

Select this option to display the current list of paired devices. Select the device to be removed by rotating and pressing the rotary encoder.

SiriusXM SATELLITE RADIO

(USA only) - Requires optional SiriusXM Vehicle Connect Tuner (not included)

Everything worth listening to is on SiriusXM, getting over 130 channels, including the most commercial-free music, plus the best sports, news, talk and entertainment. A SiriusXM Connect Tuner (sold separately) and Subscription are required. For more information, visit www.siriusxm.com.

The MS-RA205 is ready to connect to a SiriusXM Connect Tuner (service only available in 48 states). The SiriusXM tuner is an optional extra that must be purchased separately.

Enabling the SiriusXM Source

If you have installed the SiriusXM Tuner (USA Only) you will need to enable the source. Firstly, ensure the Tuner Region is set to USA.

➤ Select Settings ➤ Tuner Region ➤ USA

When USA Tuner region is selected, press the menu button and select

Settings ➤ Sources ➤ Accessory then select the source to enable SiriusXM.

Activating your SiriusXM tuner: You must activate the SiriusXM tuner before you can begin to receive the SiriusXM Radio Service.

In order to activate your radio subscription, you will need the SiriusXM ID (SXID) which uniquely identifies your tuner. The 8 digit SXID is displayed on the LCD on initialization. MS-RA205 will display the SXID on Channel 0.

Power on your system and make sure that you are receiving good signal, you are able to hear audio on the SiriusXM Preview channel (Channel 1)

To listen to SiriusXM Satellite Radio, a subscription is required. Activate the SiriusXM Vehicle Tuner using one of the two methods below:

Online: Go to www.siriusxm.com/activatenow Phone: Call 1-866-635-2349

To activate SiriusXM Canada service go to www.xmradio.ca and click on "ACTIVATE RADIO" in the top right corner, or call 1-877-438-9677

SiriusXM OPERATION

Press 'Source' to cycle to the SiriusXM Satellite radio source.

Press the 'Menu' button and turn the rotary encoder to select the desired menu option.

CHANNELS

Select the desired channel (listed in channel order) and music preference

CATEGORY

Select the desired genre type. (The unit will only play the selected option)

PADLOCK ICON

The padlock icon means the channel is locked or considered mature content. If you select this channel you will be asked to unlock parent mode, if it is not already unlocked.

PRESET TUNING MODE

Press 'Play' to cycle to preset tuning mode. Press the 'Previous' or 'Next' button to select previous or next preset.

Note: Preset function is only available when more than one preset has been saved.

PRESETS

Add your channel preset to your favourites list by selecting 'Add Preset' (Maximum 15 channels). Remove channels by selecting 'Remove Preset'. Select 'All' or the individual channel. Exit by pressing the 'Menu' button.

Alternatively: Press and hold the 'Play' button to store favourite.

PARENTAL MODE

ENABLE ON/OFF

Select to enable channels to be locked/unlocked

PIN

Turn the 'Rotary Encoder' to select number and press to enter, repeat to enter the 4 digit code. (Factory setting is 0000)

Note: Must be entered before the following items are operational.

LOCK / UNLOCK

Select the channel to be locked or unlocked

CHANGE PIN

Personalise your Pin number. (4 digits max)

PIN RESET

When on SiriusXM source, press & hold mute key for 15 seconds. PIN will be reset to '0000'.

ZONE OPERATION

The MS-RA205 Marine Stereo features Multi-Zone technology which enables 2 'Zones' with independent volume control.

ZONE SETUP

Press the 'Menu' button and select 'Settings'. Select 'Zones' then the Zone you wish to setup.

BALANCE

Select 'Balance' to adjust the balance from left to right.

VOLUME LIMIT

Select 'Volume Limit' to set the desired maximum output volume for each individual Zone.

ZONE NAME

Select 'Zone Name' to give the zone a name of your choice. Rotate the rotary encoder to change the character. Press the rotary encoder to select. Press the 'Previous' button to delete characters — To save changes press the 'Play' key — To exit without saving any changes: press the 'Menu' key.

SUBWOOFER

Adjust the sub limit and filter.

Note: From any source screen press and Hold the 'Rotary Encoder' for quick access to subwoofer level adjustment

SUB LIMIT

Press the 'Menu' button and select 'Zones'. Select 'Subwoofer' then 'Sub Limit'. Select the desired maximum subwoofer output volume.

SUB FILTER

Press the 'Menu' button and select 'Zone'. Select 'Subwoofer' then 'Filter'. Select the desired frequency. 55Hz - 85Hz - 120Hz - 160Hz

Note: Subwoofer and Lineout volume control is linked to Zone 1.

ADDITIONAL FEATURES

FUSION-Link Wired (NMEA 2000)

FUSION-Link has the ability to fully control on-board FUSION Entertainment systems (Supported models), by utilizing FUSION-Link capable multi-function displays installed at the helm, flybridge or nav station of the vessel, providing integrated entertainment control and a less cluttered console.

You can control one or more FUSION-Link capable stereo units from a single location on the boat with the touch of a button. FUSION-Link operates over existing industry standard networks including NMEA2000 .

Link Zones or manage the entire audio system from the steering station on the boat. The partnered multi-purpose display becomes the portal to which all audio on the vessel is controlled, no matter where on the vessel the stereo is installed. The FUSION-Link equipped stereo can be installed out of sight if space is an issue and users need to visit the unit only to replace removable media.

For a list of FUSION-Link capable products from companies that are partnering with FUSION, please visit www.FUSIONENTERTAINMENT.com for further details.

TOTAL AUDIO CONTROL VIA NMEA 2000

NMEA 2000 is the most popular marine standard for data communication within vessels. It has become the standard for sending navigation and engine management data within vessels. FUSION introduces an industry-first product by incorporating NMEA 2000 functionality in its audio remote control devices. This will enable the user to monitor a series of available NMEA sentences. Visit www.FUSIONENTERTAINMENT.com for a full list of supported NMEA sentences

FUSION NRX SERIES REMOTE CONTROL (SOLD SEPARATELY)

The MS-RA205 Marine Stereo can be controlled by an NRX Series wired remote control installed in the audio Zones throughout the vessel. The remote Control has a full-featured user interface. To the user, operating the entertainment system from the remote control is very similar to operating it from the main unit. It includes a full size LCD screen and provides full functionality for navigating iPods and iPhones.

FUSION's NRX Series wired remote controls are capable of operating over an existing NMEA 2000 network, removing the need to wire back to the stereo unit. Smaller or older vessels without NMEA 2000 can still have FUSION NRX Series wired remotes installed by utilising our standard FUSION remote control network.

The remote control will also serve as an NMEA repeater displaying NMEA navigation data or vessel performance data from other NMEA devices on an existing NMEA 2000 network.

TROUBLESHOOTING

RESET

Should the stereo become unresponsive. Follow the below steps:

1. Press and hold the 'Power' button for 10 seconds to reset the stereo.
2. Reset your iPod/iPhone/MTP device
3. Remove all power for 1 minute and then reconnect.

FACTORY RESET

The factory reset function will return all settings in the MS-RA205 to the factory default value.

Warning: All AM, FM station presets are erased. Tuner regions are reset to USA. All zones are enabled and zone settings, tone, subwoofer filter settings, source settings and device name are returned to default values.

To reset your MS-RA205 to factory default values:

1. Press the Menu Key.
2. Select **Settings > Update**. Select **Factory reset**. All settings will be restored to the factory default. At the completion of the reset process the stereo will automatically power down and restart.

iPod

Why does my FUSION Head unit keep locking up when connected to my iPod/iPhone?

If you are experiencing software lock-ups or your unit freezes:

- Reset your iPod/iPhone (see Apple website from model-specific information). This should resume normal operation.
- Make sure you have the latest version of iTunes and the latest operating software in your iPod/iPhone. It is important to update software when

Apple

releases new versions. If you are connected via a dock, ensure you are using the correct sleeve and the connection to the Head unit is secure.

Note: After any IOS update to your Apple iPhone we recommend resetting the iPhone to ensure correct operation. Press and hold the Sleep/Wake button and the Home button together for at least ten seconds, until the Apple logo appears.

Will my iPod/iPhone connect to my FUSION product if the battery is flat?

No. It will take a number of minutes for the Apple product to get a minimum level of charge before it can connect and become operational. Please connect and wait for the unit to initialise.

My iPod/iPhone will not connect to the head unit while in a FUSION dock accessory.

If your Head unit displays "Not Connected" while using iPod as input source:

- Check that you are using the correct sleeve combination. If you have the incorrect sleeve combination this could prevent the iPod connector from mating correctly. It could also damage the connector in the dock or your iPod/iPhone itself.

If you are uncertain which iPod model you have, go to <http://www.apple.com/support/> to get the correct model information for your iPod.

If you are still unable to connect once you know for certain you have the correct iPod/iPhone-sleeve combination:

- Ensure that you have the latest version of operating software installed in your iPod/iPhone and the latest iTunes version. To do this, connect your iPod/iPhone to iTunes and it will check and, if necessary, prompt you to download the latest version.

If you are still unable to connect:

- Contact your FUSION dealer or contact FUSION via the tech email on the FUSION website.

Problem	Solution
Bluetooth	
Why does my FUSION Head Unit not see my MS-BT200 Bluetooth Module?	If you have installed the MS-BT200 Bluetooth module or SiriusXM Tuner (USA Only) you will need to enable the source. This operation will be determined by the Tuner region you have selected. Tuner Region - USA When USA Tuner region is selected, press the menu button and select Settings>Sources>Accessory then select the source to enable SiriusXM or Bluetooth. Tuner Region - Australasia-Europe-Japan In these Tuner regions once the MS-BT200 is installed and connected the source will be available.
Why does my Bluetooth source not display all song information	The availability of song information such as song title, artist name, track duration and album cover artwork is dependent on the capability of your phone and music application. Album cover artwork and Shuffle/Repeat Status icons are not supported over Bluetooth.
My Bluetooth audio is interrupted by short breaks.	Bluetooth performs best with line-of-sight operation. Ensure the music device is not covered or obstructed and is located near the Bluetooth module. To prevent interruption to audio streaming over Bluetooth it is recommended that the Discoverable feature is turned off after pairing your device to the FUSION Stereo.
Problem	Solution
MTP Device	
Why has my MTP device become unresponsive?	FUSION recommends that folders contain no more than 300 files each. Exceeding this limitation may cause the phone to become unresponsive and the FUSION Stereo may reset the USB link to the phone. Note: Different operating systems and phones provide varying levels of support for MTP. Please refer to www.fusionelectronics.com for device compatibility information.
Why can't the FUSION stereo find my music files?	Music files must be located in a folder using one of the following names. The folder must be located in the root directory of your device. My Music My_Music mobile Music

Problem	Solution
SiriusXM	
When I press the tuner source button the SiriusXM screen is not displayed.	<p>Ensure you have the MS-RA205 Tuner region set to 'USA'. Press Menu > Settings > Tuner region > and select 'USA'.</p> <p>Ensure the source is enabled. Select; Settings>Sources>Accessory then select the source to enable SiriusXM.</p> <ul style="list-style-type: none"> • Ensure the SiriusXM module is plugged into the MS-RA205. • Unplug the SiriusXM module and check the pins in the SiriusXM plug are not damaged.
SiriusXM message: 'Check Tuner'	<ul style="list-style-type: none"> • Ensure the SiriusXM module is plugged into the MS-RA205. • Ensure the SiriusXM cable has not been damaged.
SiriusXM message: 'Check Antenna'	<ul style="list-style-type: none"> • Ensure the antenna is plugged into the SiriusXM Tuner module. • Ensure the antenna is not damaged. • Ensure the antenna cable has not been damaged
SiriusXM message: 'No Signal'	<ul style="list-style-type: none"> • Ensure the antenna is not damaged. • Ensure the antenna has a clear view of the sky and is not obscured. • Ensure the antenna cable has not been damaged
SiriusXM message: 'Channel xx Not Available'	<p>A SiriusXM message informing you that the current channel is unavailable. Possible causes are SiriusXM has removed the channel or your SiriusXM subscription has changed.</p> <ul style="list-style-type: none"> • Contact SiriusXM to update your subscription. • Online: Go to www.siriusxm.com/subscriptions • Phone: Call 1-866-635-2349
SiriusXM message: 'Channel xx Unsubscribed'	<ul style="list-style-type: none"> • Contact SiriusXM to update your subscription. • Online: Go to www.siriusxm.com/subscriptions • Phone: Call 1-866-635-2349
SiriusXM message: 'Subscription Updated'	<ul style="list-style-type: none"> • A SiriusXM message informing you that you have either been granted access to or unsubscribed from various channels. <p>For more information about your subscription:</p> <ul style="list-style-type: none"> • Online: Go to www.siriusxm.com/subscriptions • Phone: Call 1-866-635-2349

FUSION MARINE ACCESSORIES

MARINE BLUETOOTH MODULE WITH DATA DISPLAY MS-BT200

New FUSION MS-BT200 marine grade Bluetooth audio module. Certified IP65 water resistant and tested for the marine environment, the MS-BT200 is designed to connect to the MS-RA205 via the Satellite radio connector of the unit.

The MS-BT200 module streams audio from any A2DP Bluetooth capable Apple, Android, Windows, Blackberry or other device directly to the MS-RA205.

Note: The MS-BT200 cannot be operated simultaneously with a Satellite Radio (SiriusXM) receiver or DAB module. For installations where the Satellite Radio (SiriusXM) socket is not available the FUSION MS-BT100 audio only Bluetooth module is recommended.



Marine UNI-Dock (MS-UNIDOCK)

The revolutionary UNI-Dock supports the widest array of smart phones, media players and USB devices on the market. The UNI-Dock charges and protects your device from the harsh marine environment. It allows users to enjoy on-the-water entertainment from an extensive range of Apple and supported MTP (Media Transfer Protocol) enabled Android smartphones.



CONNECTING TO AN EXISTING NMEA 2000 NETWORK

Connect the FUSION MS-RA205 Marine Stereo to an existing NMEA 2000 network with FUSION optional accessories:

MS-RA205 NMEA 2000 Drop Cable: CAB000863

FUSION NMEA 2000 T-Connector: CAB000581

MARINE ACTIVE SUBWOOFER MS-AB206

Features a down firing bass reflex enclosure and its own internal Active 210 Watt amplifier allowing easy connection to the music source delivering crisp clear low frequency reproduction from any music selection.



IPX 7 NMEA 2000 MARINE WIRED REMOTE MS-NRX300

The MS-NRX300 NMEA 2000 Certified Wired Remote Control is an out of the box solution for adding localized control of a compatible FUSION marine entertainment system to any vessel. Up to three remotes can be linked to the Stereo, providing true system flexibility.



MARINE ZONE AMPLIFIER MS-AM702

The Marine 2x70 Watt D-Class Zone Amplifier is designed to support the Multi-Zone technology of the Marine Stereo. The Zone Amplifier is small, enabling discrete installation and when combined with the Marine Stereo provides the platform for a True Multi-Zone audio system.



MARINE 5 CHANNEL AMPLIFIER MS-DA51600

Add more power and increase the bass level of your music of your FUSION Marine Audio System by connecting a 5-Channel Amplifier. Built for the harsh marine environment with conformal coated PCB.



SPECIFICATIONS AND LICENSING

SPECIFICATIONS

CHASSIS DIMENSIONS FACE PLATE DIMENSIONS

Depth 93mm - 3-5/8" Depth 29mm - 1-1/8"
 Width 130mm - 5-1/16" Width 157mm - 6-3/16"
 Height 50mm - 2" Height 68mm - 2-11/16"

OPERATING VOLTAGE: 10.8 - 16VDC Negative ground
 FUSE RATING: 15 Amp
 OUTPUT POWER: 50 Watts x 4 (Max)
 SPEAKER IMPEDANCE: 4 Ohms per channel
 PRE - OUTPUT VOLTAGE: 3V

TUNING RANGE

EUROPE AND AUSTRALASIA:

AM Radio
 Frequency Range: 522 - 1620 kHz
 Frequency step: 9 kHz
 50 kHz

USA

AM Radio
 Frequency Range: 530 - 1710 kHz
 Frequency step: 10 kHz
 200 kHz

JAPAN

AM Radio
 Frequency Range: 76 - 90 MHz
 Frequency step: 9 kHz
 50 kHz

FCC COMPLIANCE STATEMENT

This device complies with part 15 of the FCC rules. Operation is subject to the following two conditions: This device may not cause harmful interference AND This device must accept any interference received, including interference that may cause undesired operation.

LICENSING

Apple, the Apple logo, iPod, iPhone, 'Made for iPod' and 'Made for iPhone' are Trademarks of Apple Computer, Inc., registered in the U.S. and other countries.

SiriusXM, XM and all related marks and logos are trademarks of SiriusXM Radio Inc. All rights reserved.

NMEA 2000 is a registered Trademark of the National Marine Electronics Association, Inc.



PUBLISHED BY FUSION ENTERTAINMENT LIMITED. © Copyright 2016 by FUSION Electronics Limited. All rights reserved. Specifications and design are subject to change without notice. YOU CAN HELP PROTECT THE ENVIRONMENT Please remember to respect the local regulations: Hand in the non-working electrical equipment to an appropriate waste disposal centre. v1.2x

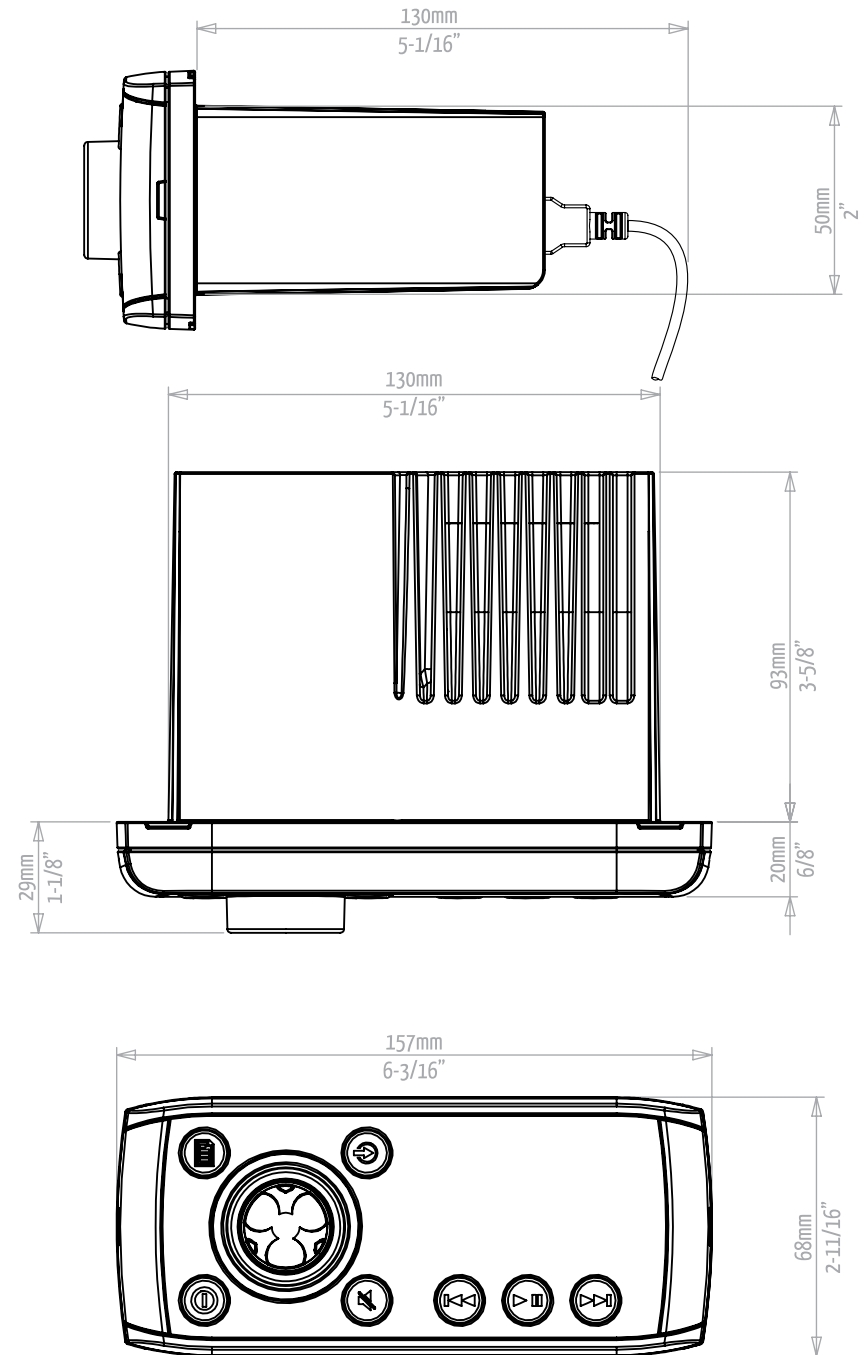

FUSION SUPPORT

New Zealand	09 369 2900
Australia	1300 736 012
Europe	+44 (0) 370 8501242
USA	623 580 9000
Pacific	+64 9 369 2900

© 2016 Garmin Ltd. or its subsidiaries



Garmin®, the Garmin logo, and the FUSION® logo are trademarks of Garmin Ltd. or its subsidiaries, registered in the USA and other countries. FUSION is trademarks of Garmin Ltd. or its subsidiaries. These trademarks may not be used without the express permission of Garmin.

Apple®, the Apple logo, iPod®, iPod touch®, iPod classic®, iPod nano® and iPhone® are trademarks of Apple Inc., registered in the U.S. and other countries. Android™ is a trademark of Google Inc. Bluetooth® word mark and logos are owned by the Bluetooth SIG, Inc. and any use of such marks by Garmin is under license. Other trademarks and trade names are those of their respective owners.

FUSION®

FUSIONENTERTAINMENT.COM

190-01934-90_0X
June 2016

Printed in Thailand